

LUMI Keys 1 & LUMI Keys SE

User Manual

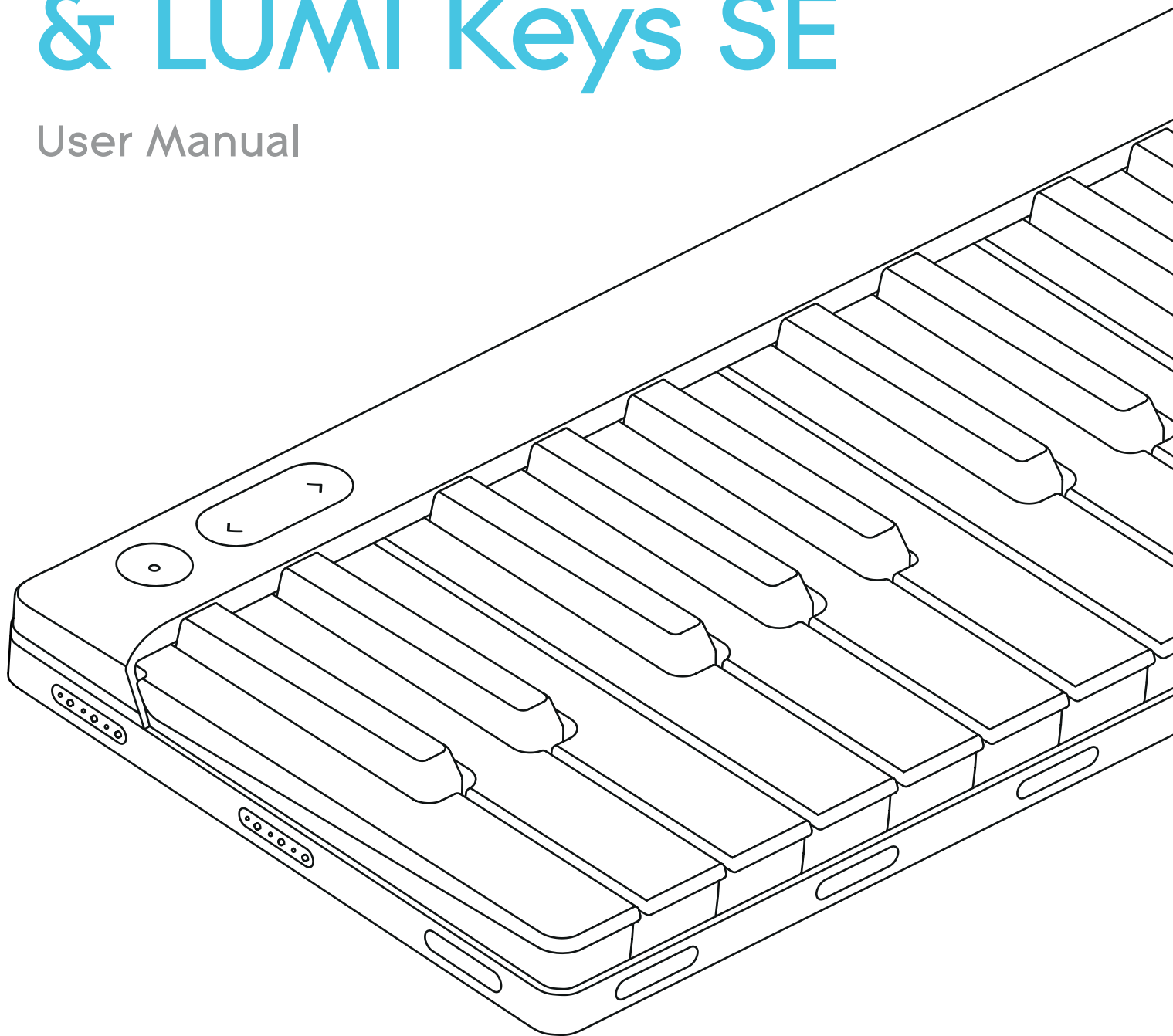

LUMI

TABLE OF CONTENTS

03 - Introduction

04 - Glossary of Terms

06 - LUMI Overview

08 - Getting Started

11 - Controls and Functions

14 - How to Play

16 - Features and uses for Musicians

INTRODUCTION

You're about to start exploring a new way to learn the piano. We're thrilled that you're on your way! LUMI is an integrated, interactive system that's the first of its kind. It combines a brilliantly illuminated keyboard with an app that's full of songs, lessons, exercises and games. Choose where you start. Wherever that is, you'll play as you learn, learn as you play, and build skills in a much more fun way than conventional piano lessons.

LUMI is for beginners, offering step-by-step guidance in learning the piano basics. But it's also a state-of-the-art MIDI keyboard that can slot into any musician's workflow. It integrates with software tools like ROLI Studio, Logic Pro, and GarageBand that millions of people use, and its unique light-activated features are fully customizable.

In this manual you'll learn how to use LUMI, whether you're playing a keyboard for the first time or connecting it to other devices in a studio. We'll be updating the manual whenever we add new features. So check back in once in a while!

Happy exploring
Team ROLI

Please note: LUMI Keys may display flashing lights and patterns which may pose a risk to individuals with photosensitive epilepsy.

GLOSSARY OF TERMS

BLOCKS:

A system of modular MIDI controllers that connect through magnetic DNA connectors to create customizable, adaptable kits. The Seaboard Block, Lightpad Block, Live Block, Loop Block, and Touch Block currently comprise the system. LUMI Keys also connects to BLOCKS.

Block(s):

The individual controllers within the BLOCKS system.

Brightkey Technology:

ROLI's proprietary technology that controls the fully illuminated RGB keys of the LUMI keyboard.

Control Block:

The Loop Block, Live Block and Touch Block. They are auxiliary Blocks that give music makers additional control over music made on the Lightpad Block, Seaboard Block, or LUMI Keys. Control Blocks can also send MIDI messages to third-party applications.

DNA Connectors:

Six-pin connectors that magnetically connect multiple LUMI Keys or Blocks and also transmit power and data between the connected units.

DS5.5 Keys:

LUMI's keys conform to DS 5.5 on the Donison Steinbuhler Standard. Approximately 7/8 the width of a standard piano key, they better fit the size of the average human hand.

LUMI Music:

The LUMI Music app is the mobile app companion to LUMI Keys. Syncing the app on phone or tablet with LUMI Keys, you can choose songs and learn to play them through interactive content.

Loop Block:

An auxiliary Control Block that provides shortcut buttons to production features like recording, playback, and quantizing.

Lightpad Block:

A next-generation drumpad for playing beats and melodies, as well as producing and controlling effects on other Blocks in the BLOCKS system. Lightpad Block integrates fully with LUMI.

Live Block:

an auxiliary Control Block that provides shortcut buttons to performance features like switching sounds, turning notes into chords, and arpeggiating. When LUMI is connected to ROLI Studio Player software, Live Block controls software functions directly.

LUMI Keys:

That's this product! LUMI Keys is the fully illuminated keyboard, distinct from the LUMI Music app.

MIDI Polyphonic Expression (MPE):

MPE is an emerging protocol that enables deeper musical expression in digital music creation tools. MPE-compliant devices (like the ROLI Seaboard) and software (like Logic Pro X and Bitwig Studio) enable independent, per-note control of multiple sound parameters such as pitch and timbre. ROLI is a pioneer of MPE, which was adopted as part of the MIDI specification in 2018.

Polyphonic Per-key Pitchbend:

The unique key action and sensor design allows LUMI Keys to provide per key polyphonic pitchbend. This means that you can bend the pitch of one or more keys at the same time with a lateral, vibrato-like finger movement.

Polyphonic Aftertouch:

With specific settings enabled in ROLI Dashboard, users can modulate sound through continuous pressure applied to a single or multiple keys, polyphonically. This is called Aftertouch.

ROLI Connect:

A desktop application for players who use ROLI software. ROLI Connect is a portal of managing multiple ROLI products, and accessing software updates.

ROLI Dashboard:

A desktop application for modifying and customising the internal settings of LUMI Keys and other ROLI devices. ROLI Dashboard is especially useful for skilled electronic musicians who want to integrate LUMI with digital audio workstations and synthesizers.

ROLI Studio:

A desktop application that includes 100s of sounds, effects, and production tools from across the ROLI software ecosystem. It includes two plugins: ROLI Studio Player and ROLI Studio Drums.

Seaboard Block:

A next-generation keyboard for playing and shaping sounds with far more expression than a normal piano keyboard allows. Seaboard Block connects LUMI Keys as well as the Lightpad Block and others in the BLOCKS system.

Touch Block:

An auxiliary Control Block that allows real-time control of expression parameters on the Seaboard Block and Lightpad Block.

USB-C:

The type of USB connector used to connect and charge LUMI Keys. There is a female connector on the keyboard, and a male connector on the included USB-C-to-USB-A cable.

Bluetooth + MIDI Over Bluetooth:

Bluetooth is the wireless communications protocol that allows your LUMI Keys to connect to your mobile device or your laptop or desktop (if you are a Mac user). LUMI Keys utilizes MIDI Over Bluetooth, a type of Bluetooth that is used for all MIDI-receiving instruments. It does not work in the same way as a Bluetooth speaker. You can only connect to your LUMI Keys via Bluetooth by using an app that is capable of handling MIDI over Bluetooth connections, such as the LUMI Music App.

LUMI OVERVIEW

LUMI is a platform that spans hardware and software, going beyond the uniquely illuminated keyboard and encompassing the software tools that make the most of its illumination, modularity, MPE touch, and other capabilities.

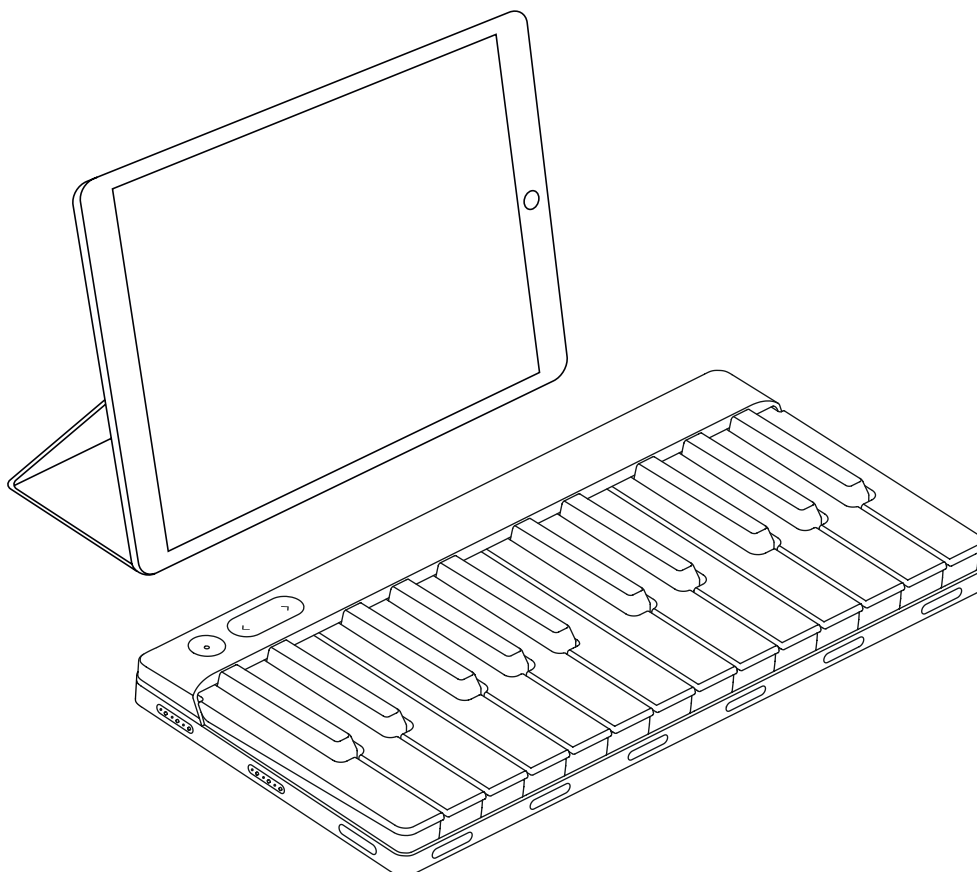

WHAT IS LUMI?

LUMI is three things, all interacting as one.

HARDWARE: LUMI Keys 1, the illuminated keyboard.

SOFTWARE: The LUMI app is free for everyone, ROLI Studio Player comes only with the LUMI Keys SE version.

CONTENT: 100s of songs and dozens of lessons are contained within the LUMI app. For those who purchased LUMI Keys SE, ROLI Studio Player comes with hundreds of sound presets.

WHAT IS LUMI FOR?

PLAYING: Play songs you love, chosen in the LUMI app. And if you want, go further and play anything you want, because LUMI Keys is a versatile MIDI keyboard.

LEARNING: Learn how to play the keyboard by practicing songs in a fun, interactive way; then step back and take bite-sized in-app lessons about technique and other music basics.

WHO IS LUMI FOR

LEARNERS: LUMI is primarily for people who don't yet play an instrument confidently. This will always be the biggest group, because there are tens of millions of people who don't play, but wish they could.

MUSICIANS: LUMI Keys, and the included desktop software, are also extremely powerful tools for skilled musicians who want to bring a new keyboard, new sounds, and even a spectacular new look to their playing and producing.

LUMI KEYS FEATURES:

- 24 fully illuminated RGB keys
- Unique modular design with 4 DNA connectors for easily expanding and attaching to other controllers in the BLOCKS family.
- Custom-sized DS5.5 keys better sized for the average human hand
- Bluetooth connectivity
- Lightweight, compact, portable design
- 5 Hour battery life
- USB-C connectivity
- Octave Shift capability
- Multiple colour modes

GETTING STARTED



UNBOXING

Unbox your LUMI carefully. Check the contents to make sure that nothing is lost or damaged. We recommend saving all packing materials, just in case.

BOX CONTENTS

- LUMI Keys
- USB-C cable
- Warranty overview

CHARGE

Before you do anything else, charge your LUMI Keys. Use the USB-C cable included with your LUMI Keys. Plug the USB-C cable into your LUMI Keys and plug the other end of the cable into a USB 3 charger or a computer with a USB 3 port.

A green light on the Power/Mode button indicates a full charge.

With your LUMI Keys turned off, simply plug it into a USB charger. You will see that the power indicator light on the power button blinks for approximately 5 seconds, in the colour that indicates the battery charge level before turning off.

Red: Less than 20% charge

Amber: Between 20% and 88%

Green: Greater than 88%

If you want to check the charge level of your LUMI Keys, just turn it on and look at the LED colour of the power button indicator light.

LEARNING HOW TO PLAY? DOWNLOAD THE LUMI APP

LUMI Keys connects to the LUMI app. Download from the Apple App Store or Google Play.

Supported mobile devices: The LUMI app works with mobile and tablet devices.

Check our [Support page](#) for a full list of supported Android and iOS devices.

Register your keyboard: When it's charged, go ahead and register your keyboard with the LUMI Music App. Launch the app. Follow instructions to create a user account, or log in with your existing account. Then register.

PAIR LUMI KEYS WITH THE LUMI APP

You'll need to pair the app and the keyboard to start playing.

Your first connection to the app: When you switch the keyboard on, it will automatically enter Bluetooth pairing mode. You'll know this when the keys pulses with blue light. Then open the LUMI app, which will ask you to pair with LUMI Keys. After pairing, the keys will animate in a rainbow display.

Please note that your LUMI Keys does not connect to your mobile device in the same way as your Bluetooth speaker. LUMI Keys uses MIDI Over Bluetooth, which requires you to pair with MIDI Bluetooth-enabled app like the LUMI app.

If you are using two LUMI Keys together, follow the on-screen instructions in the LUMI app to connect the second keyboard.

Reconnecting to the LUMI App: If you have lost connection, a dialogue box will pop up on the LUMI App, assisting you with re-connection. If you have exited this dialogue box without reconnecting, you can always tap the bluetooth icon  in the top right corner of the LUMI app to select your LUMI keys; just make sure your LUMI Keys is displaying the blue wave across the keys, so you know it is ready to pair over bluetooth. Find your device name and tap. This will reconnect the keyboard and app.

ARE YOU A MUSIC MAKER? DOWNLOAD ROLI SOFTWARE TO GET STARTED.

If you've gotten LUMI Keys Studio Edition or LUMI Kickstarter Edition, you're entitled to desktop music production software such as ROLI Studio. Just visit rolicompany.com/start to download and install the ROLI Connect application. Then, within connect you can download and install all your software entitlements.

Minimum System Requirements: You can find more information on minimum system requirements to run ROLI Software [here](#).

Register your keyboard: You can register your new hardware through ROLI Connect.

CONTROLS AND FUNCTIONS

LUMI Keys includes a 24-key illuminated playing surface, a power/mode button, an octave switch button, a USB-C port, 4 DNA connectors, and wireless Bluetooth connectivity.

THE KEYS

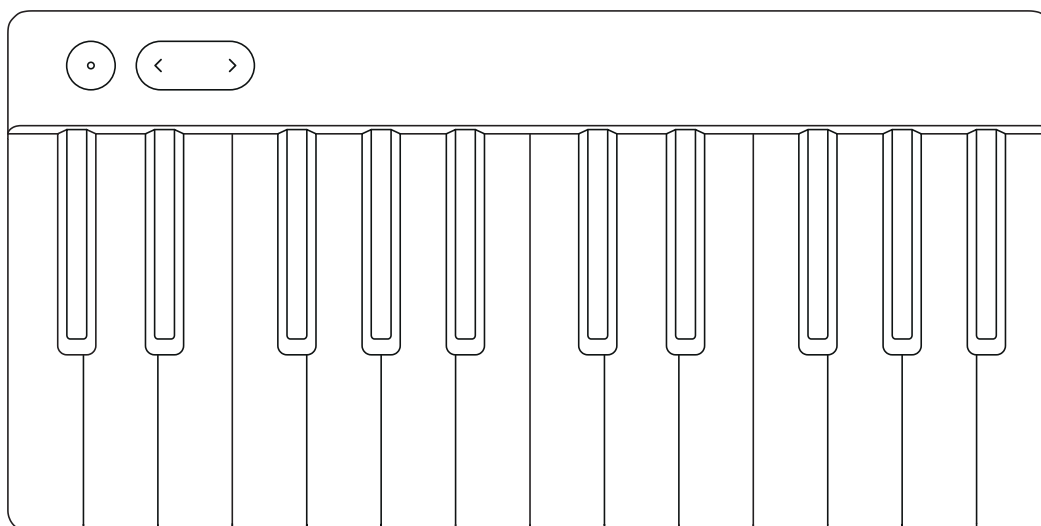

The keys operate like standard MIDI keyboard keys, but they are different in two ways:

Illumination: The keys are brightly lit with full-spectrum RGB illumination, enabled through ROLI Brightkey technology. Each key will appear in a variety of colors depending on what song or program you are accessing.

Key size: The keys conform to DS 5.5 on the Donison-Steinbuhler Standard. They are $\frac{7}{8}$ the width of a standard piano key. Their slightly slimmer profile makes them better sized for the average human hand and more comfortable for playing.

CONTROL BUTTONS

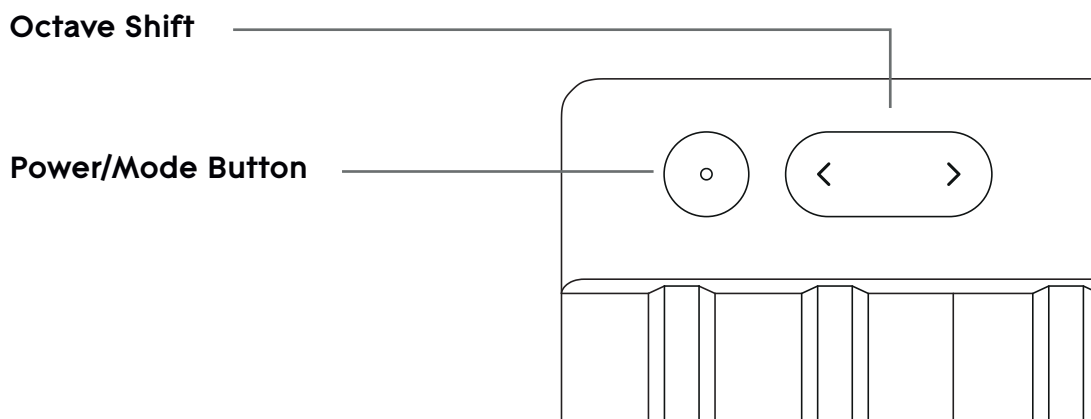

There are three buttons, each with multiple functions.

Power/Mode Button: Located on the top left of the keyboard. Its functions are:

On/Off: Turn the keyboard on by pressing the button once. Turn it off by holding it down for three seconds.

Battery Indicator: The color of the LED in the button also indicates battery life. Green is full charge, yellow is medium charge, and red is low (20% or less battery life remaining). The button will blink when LUMI is connected to a power source and is charging.

MODE Selection: (MIDI Controller use only) When using your LUMI Keys as a MIDI controller with your DAW, the power button also lets you cycle between the MIDI Modes. See “Features and Uses for Musicians” for more information.

Octave Shift: Located next to the Power/Mode button. For advanced users who are composing or performing with LUMI Keys, the button is for moving up and down octaves beyond the two-octave range of the keyboard.

The power button and the octave shift buttons also work together in special combinations to access more advanced features. See the “Features For Musicians” section below.

BLUETOOTH CONNECTION INDICATOR

When you turn on LUMI Keys without a wired USB connection, it will start pairing with Bluetooth. The Bluetooth pairing process is indicated by the keys pulsing blue. Once the connection is established, the keys will flash in a rainbow pattern.

USB CONNECTION

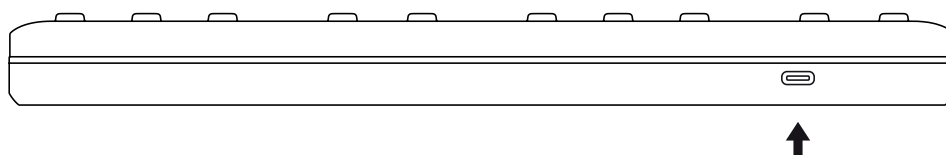

Located on the top of LUMI Keys, the USB-C port connects to a USB 3 charger to charge the keyboard. The keyboard's battery will charge when connected to a computer that itself is plugged in to AC power.

DNA CONNECTORS

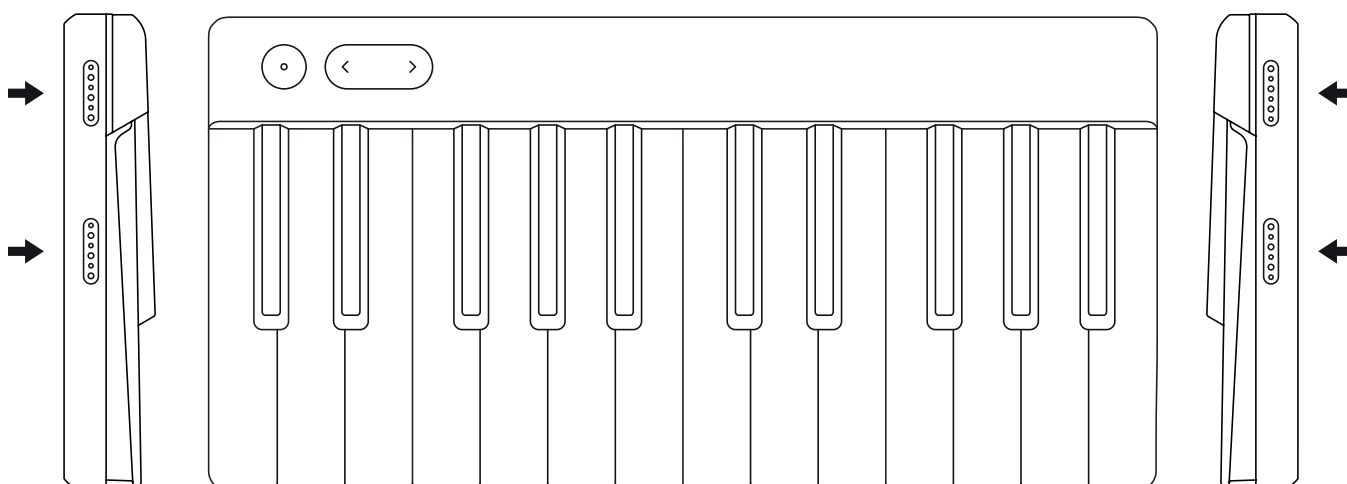

Located on the left and right sides of LUMI Keys, DNA connectors magnetically connect two or more LUMI Keys and share data and electrical current across the keyboards. This allows multiple LUMI Keys to automatically behave as a single, continuous keyboard.

HOW TO PLAY

When LUMI Keys is connected to the App, you're all set to choose a song or lesson and start playing.

Choosing songs

Hundreds of songs are available, spanning the range from pop to classical to dance music. The free LUMI Essential tier is full of well-known classical and folk songs, and the subscription-based LUMI Complete tier has over 500 songs, including over 300 contemporary songs.

Your interface for choosing songs looks like this.

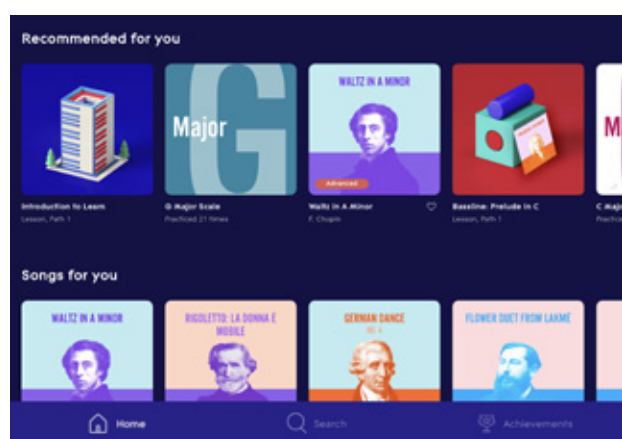

Choosing views

After you've chosen a song, the next step is choosing how you want to view or "read" your song. Options include Cascade View and Rainbow View.

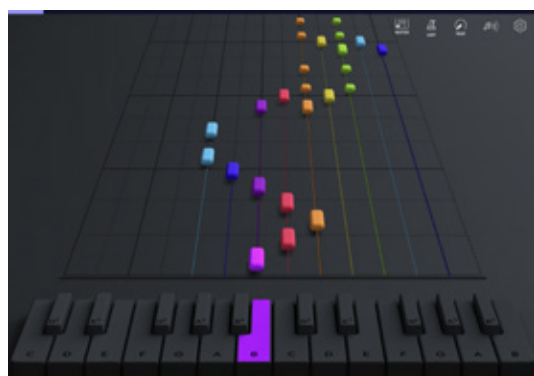

Cascade View

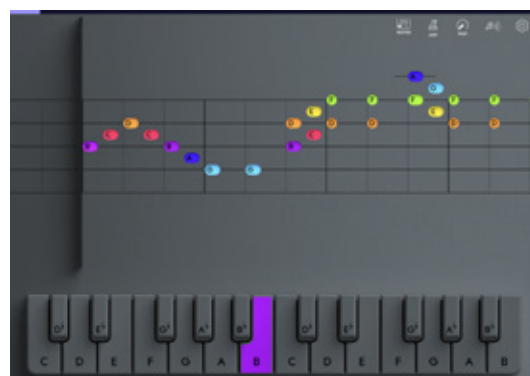

Rainbow View

Exploring lessons

The best resources for learning how to play are in the Learn section of the app. There you will find instructional content about subjects like:

Playing technique

Play songs that build your right hand and left hand keyboard skills. Learn to play in step, in jumps, and how to cross fingers.



Music fundamentals

Get to grips with musical basics, including pitch, dynamics, scales and rhythm. Use what you've learned to improve every performance, and play more complex music.

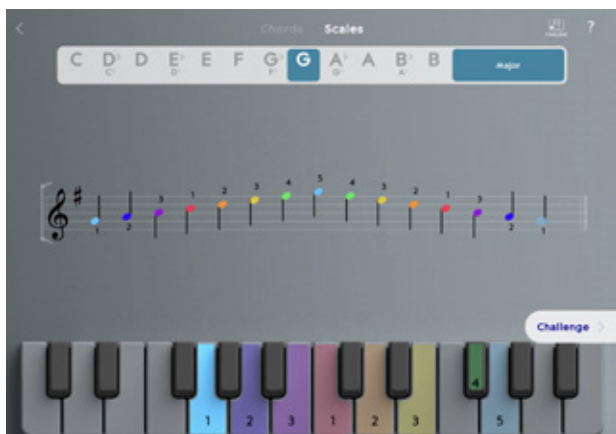

Reading sheet music

Begin reading notes on the musical staff. Familiarize yourself with different note symbols, then play your favorite songs with traditional sheet music.

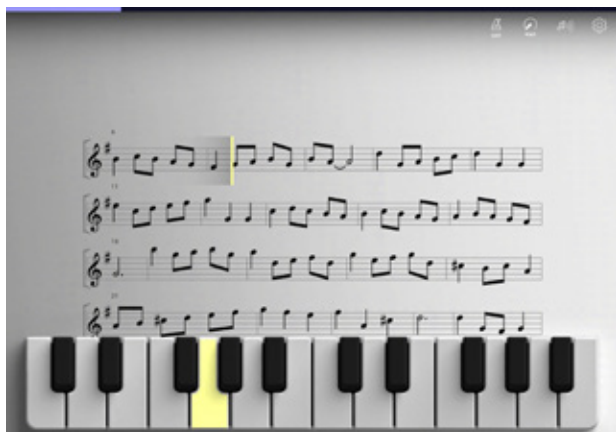

Dive into Games

LUMI Games reinforce your piano playing skills, helping you master music technique in the most fun possible way. Navigate among the games through the home screen of the LUMI app.

FEATURES AND USES FOR MUSICIANS

LUMI Keys helps learners take their first steps toward playing songs they love. But it is also a versatile, portable, and technologically advanced keyboard with groundbreaking applications for skilled keyboardists. This section outlines key features and uses for musicians.

CUTTING-EDGE SOFTWARE

Explore a suite of pro software

LUMI Keys SE comes with ROLI Studio with hundreds of sounds, effects, and production tools. Download them and unlock the full potential of LUMI as an illuminated, high-performance MIDI keyboard.



ROLI Studio Player

A desktop plugin with 300+ acoustic, hybrid acoustic, and synth sounds plus audio effects and production tools including Smart Chords and Multi Layered Arpeggiator, comes complete with LUMI Keys SE



ROLI Studio Drums

A desktop plugin with 200+ percussion sounds, powered by the world's first MPE drums engine that can bend and warp drum sounds at the touch of a finger. ROLI Studio Drums is maximises the power and versatility of the Lightpad BLOCK



ROLI Dashboard

A tool for configuring LUMI to work with DAWs and third-party software plugins



ROLI Connect

A cloud-based platform for downloading software and managing connections between multiple LUMI Keys and ROLI Blocks.

Access your ROLI software

To access your software entitlements associated with your hardware, download ROLI Connect for free. Follow instructions in the ROLI Support article about ROLI Connect.

Connect LUMI Keys to DAWs and plugins

As a MIDI class compliant device, LUMI connects to Logic Pro X, Ableton Live, Bitwig Studio, and other digital audio workstations (DAWs) that support MIDI device inputs. It is also compatible with plugins used within DAWs.

Find detailed guides about working with most DAWs on the ROLI Support page. If you do not see your DAW on the list, get in touch with the Support Team through our Support page.

EXPANDABLE HARDWARE

Connect multiple LUMI Keys

Connect two or three LUMI keyboards together to expand your playing surface. Multiple LUMI Keys snap together magnetically with DNA Connectors. Through ROLI Dashboard, assign sounds to the entire LUMI interface, or to each individual keyboard.

Note that the LUMI app currently only supports a maximum of two LUMI Keys.

Connect LUMI Keys to ROLI BLOCKS

With its slim, compact profile and magnetic DNA Connectors, LUMI Keys is technologically part of the ROLI BLOCKS family. It works seamlessly with the Lightpad Block and Seaboard Block. Through ROLI Dashboard, assign different functions to each Block, plus LUMI Keys.

Note: When A LUMI Keys is connected via the magnetic DNA connectors to another block that is charging via a USB charger, LUMI will charge through the magnetic DNA Connection.

INTEGRATE LUMI WITH OTHER MIDI CONTROLLERS IN YOUR WORKFLOW

LUMI Keys also integrates easily with MIDI keyboards, drumpads, and other MIDI receiving devices in a studio-based workflow.

Although LUMI Keys does not have traditional five-pin DIN connectors, it connects to devices that do. One way to connect is via computer that transmits MIDI via a MIDI interface.

UPDATES THROUGH FIRMWARE

When you use LUMI Keys with ROLI Dashboard, the application automatically checks the firmware running on the keyboard. If a later version is available, you will be prompted to update. This is optional, but it's advisable to update to receive new features and fix bugs.

When you are using the LUMI Music App, firmware updates automatically happen in the background while you use the app.

ADVANCED USE OF CONTROLS

Custom Modes

When connected to a DAW, the Power/Mode button enables you to customize the keyboard illumination and MPE touch response. There are four default modes, and you can cycle through the modes by pressing the Power/Mode button. The following is a description of the default setting of all four modes, however Colour, Pitchbend, and After Touch are all configurable in each mode.

ROLI Pro Mode:

This mode activates both aftertouch and per-key pitchbend, for full expression. It lights up the root note of your chosen scale.

User Mode:

This activates aftertouch while letting you customize the color of your keys. It illuminates the root note and other notes in default colors. When you play a note, all other keys dim down by 50% to highlight the played note. Force of pressure also changes the color intensity of the key, with maximum color achieved through firmest pressure.

Piano Mode:

This mode transforms the keys to black and white, like a classic keyboard with glowing white keys. Pitchbend and aftertouch are turned off, again to simulate a regular keyboard response.

Stage Mode:

All keys display the below rainbow pallet at 20% brightness until played, at which point they color-max at 100% brightness. Pitchbend is enabled by default in this mode.



Octave Shift:

Pressing the octave shift button once to the right raises the LUMI Keys pitch by an octave. Pressing to the left lowers pitch by an octave. With use of the octave shift feature one LUMI Keys can reach every MIDI note from C-2 to G8.

Changing Sensitivities

In ROLI Dashboard you can adjust the Strike (Velocity), Press (Pressure), and Lift (Note-off Velocity) sensitivities to suit your playing style or the needs of your project.

Strike: Adjust the curve to make it more or less sensitive

Press: Adjust control to make pressure values more consistent

Lift: Adjust control to make note-off velocity more consistent

Firmware Reset:

Press and hold all three buttons (Power/Mode, and both octave shift buttons) for three seconds to reset the firmware.

Dashboard Settings

MIDI Settings Section: MIDI Mode: Configures the way in which your LUMI Keys sends MIDI Data. Depending on your selection here different channel settings become available directly below.

Pitch Bend Range: Match this value with your software synthesizer to have a 1:1 input to output ratio.

Octave: Shift the notes up and down in Octaves, ie C3 - B4 or C2 - B3

Transpose: Shift the notes in semitones, ie with a Transpose value of 2, the first key on the LUMI will play a D

Strike Sensitivity: Adjust the curve to make note-on velocity more or less sensitive

Press Sensitivity: Adjust the curve to make Channel Pressure or Poly Aftertouch more or less sensitive

Lift Sensitivity: Adjust the curve to make note-off velocity more or less sensitive

Fixed Velocity: Set a consistent velocity value independent of how hard you play

Fixed Velocity Value: Set the fixed velocity value if Fixed Velocity is enabled

Keybed State

Active Mode: Select between different lighting modes, each with their own default settings, or customised settings if you have adjusted them in Dashboard.

Scale: Set the scale for color display, ie Major or Minor

Key: Set the root note for Key and Scale display, ie C or D#

Pitch Bend Tracking: In Single Channel mode, or when playing a number of notes greater than the MIDI Channel range of the LUMI, determines which played note will have its pitch bend applied:

- Last Note Played
- Highest Note Played
- Lowest Note Played

Pressure Tracking: Sets between Poly Aftertouch or Channel Pressure. Due to channel pressure being global for all notes played, there are two options:

- Poly Aftertouch
- Channel Pressure

Both Channel Pressure and Poly Aftertouch are MIDI aftertouch messages which respond when pressure is applied to a key after the initial note-on. Some software will not respond to both types of aftertouch, so ROLI Dashboard includes the ability to select one or the other. If your instrument is set to respond to aftertouch but does not seem to respond to key pressure variation, try changing the Pressure Tracking.

Global Key Color: Sets the color of the in scale notes when in User Color scheme

Root Color: Sets the color of the root notes when in User Color scheme

Brightness: Sets the global maximum brightness of the keys

Mode 1 / Mode 2 / Mode 3 / Mode 4: These columns of check boxes let you decide which features are active in each mode. Options for each mode include:

- Color Scheme
- Enable Pitch Bend (On/Off)
- Enable Pressure (On/Off)

Color Scheme: Switches between:

Pro - Lights up the Scale with a highlighted root note

User - Lights up with the configured User Colours

Piano - Lights up with black and white keys

Stage - Dimmed keys only light up when pressed

Rainbow - Sets a color per note

SPECIFICATIONS

Keys: 24 full spectrum illuminated keys featuring ROLI Brightkey™ technology

Key Size: DS5.5®, 9.67mm wide high keys, 19.4mm wide low keys

Octave Range: 2 octaves with octave shift buttons for full 7 octaves

Modular Design: 4 DNA connectors for connecting additional LUMI's or ROLI BLOCKS

Battery: Rechargeable Lithium battery (2,300 mAh) for 5 hours of fully illuminated playing. 4-5 hours charge time.

Connectivity: Bluetooth 5.0 and USB-C port (MIDI out and power)

Bluetooth Range: 15 meters (50 feet)

Dimensions: (L x W x D) 282mm x 141mm x 27mm (11" x 5.5" x 1")

Expressive Performance: Pressure responsive keys featuring Polyphonic Aftertouch

Weight: 677g (1.5lbs)

ACCESSORIES

LUMI Snapcase (available in a range of colours)

Compatible BLOCKS Products

- Seaboard Block
- Lightpad Block
- Live Block
- Loop Block
- Touch Block
- Songmaker Kit

SERVICE AND SUPPORT INFORMATION

SUPPORT

We want you to have the best experience possible with our instruments and would love to hear your feedback. Should you have any questions, experience any problems, or just want to say hello, please don't hesitate to get in touch.

The easiest way to reach us is to send a support enquiry from playlumi.com/support. We will respond as soon as possible.

CARE AND MAINTENANCE

Basic care and attention will protect your LUMI Keys and help it stay in optimal condition for years to come. Avoid excessive force on the keys, and try to keep the LUMI Keys away from direct sunlight, sharp objects, liquids, and especially oils and detergents – including greasy fingers after eating food.

To clean the key surface you may use a dry or slightly damp microfibre cloth. Do not use detergents or any chemical cleansing agents, bleaches or alcohol on the LUMI Keys. Do not spray any cleaning fluids directly on your LUMI Keys, instead spray water onto a microfibre cloth first. If a cleaning agent is needed, use a microfibre cloth slightly dampened with a mild soapy water.

When not in use, it's best to store the LUMI Keys horizontally, as in normal playing position.

If you anticipate not using your LUMI Keys for three months or longer, we recommend that you take the following steps to ensure its functionality:

- Keep it fully charged when not in use.
- Store it in an environment with low humidity and a temperature between 10-25°C.
- Keep it away from corrosive gas.

- Store your device in a LUMI Keys snap case, soft case, backpack or suitable container.
- Do not store any items on top of your LUMI Keys.

To protect the health of the lithium polymer battery, we recommend you charge your LUMI Keys every six months at the minimum.

WARRANTY RETURNS AND REPAIR

To return or have your LUMI Keys repaired under warranty you must obtain an RMA (Return Material Authorization) number. Please contact the support team via support.roli.com to request an RMA number.

Once you have received the RMA number please carefully pack the LUMI Keys and ship the product to the address provided to you by the support team with transportation and insurance charges paid.

Once received, we will examine the product for any obvious signs of user abuse or damage as a result of transport. If the product is abused, damaged in transit, or is out of warranty, we will contact you with an estimate of the repair cost. Warranty work and return shipping will be performed free of charge.

Warranty and repair policies are subject to change.

Please see all of ROLI's most current policies at: www.roli.com/legal

COPYRIGHT

LUMI is a registered trademark of ROLI LIMITED. The information in this manual is subject to change without notice. LUMI, BRIGHTKEY and BLOCKS and variations thereof are trademarks owned by ROLI and may be registered.

The whole content of the manual is subject to copyrights. All copyrights on the content of the LUMI keys User Manual remains the property of ROLI. Any reproduction, transfer, alteration or utilisation of the manual and of the trademarks of ROLI for a public and/or commercial purpose without prior written consent of ROLI is prohibited.

DISCLAIMER

Information in this User's Manual is subject to change without notice and does not represent a commitment on the part of ROLI. ROLI assumes no responsibility for any inaccuracies that may be contained in this User's Manual. ROLI makes no commitment to update or keep current the information in this User's Manual, and reserves the right to make improvements to this User's Manual and/or to the product described in this User's Manual, at any time without notice.

©2019 ROLI Ltd.

SAFETY NOTE

There are no user serviceable parts in LUMI. Refer all servicing via ticket submission to support.roli.com only.